

08-SP85007

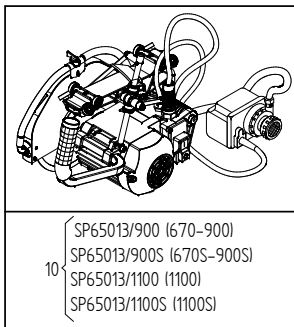

10
 SP65013/900 (670-900)
 SP65013/900S (670S-900S)
 SP65013/1100 (1100)
 SP65013/1100S (1100S)

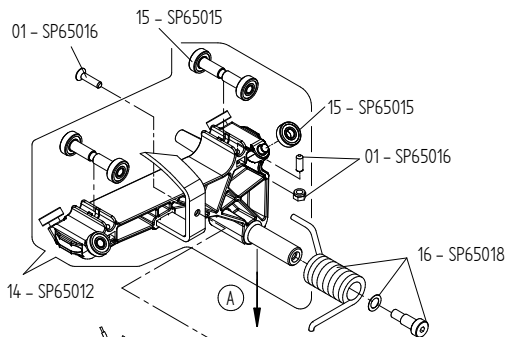

14-SP65012

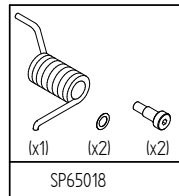

SP65018

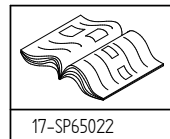

17-SP65022

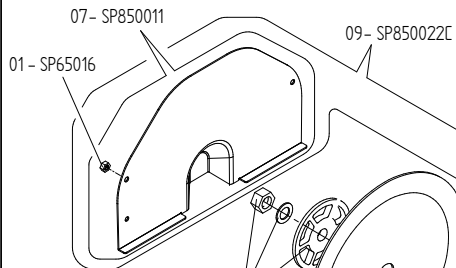

09-SP850022C

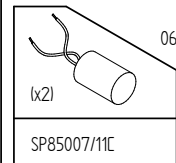

SP85007/11C

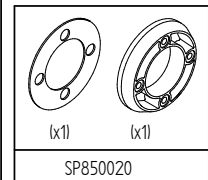

SP850020

06-SP81807/2

01-SP65016

04-SP850020

23-SP850065

05-SP850021

04-SP850020

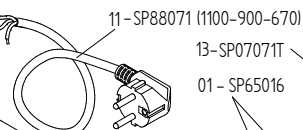

11-SP88071 (1100-900-670)

13-SP07071T

01-SP65016

12-SP850054

01-SP65016

19-SP850077

01-SP65016

20-SP85007/11C

01-SP65016

01-SP65016

21-SP90080

22-SP850025

01-SP65016

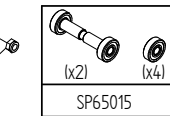

SP65015

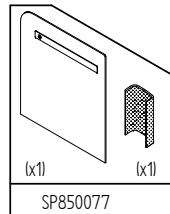

SP850077

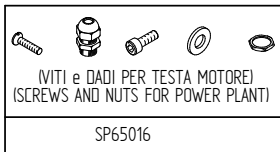

(VITI e DADI PER TESTA MOTORE)
 (SCREWS AND NUTS FOR POWER PLANT)

SP65016

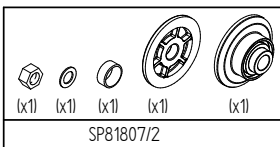

SP81807/2

03
 SP850033 (670-670S-900-900S)
 SP856033 (1100-1100S)

01-SP65016

02-SP850024

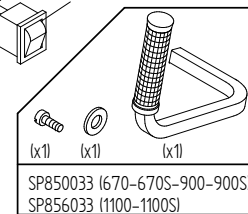

SP850033 (670-670S-900-900S)
 SP856033 (1100-1100S)

