

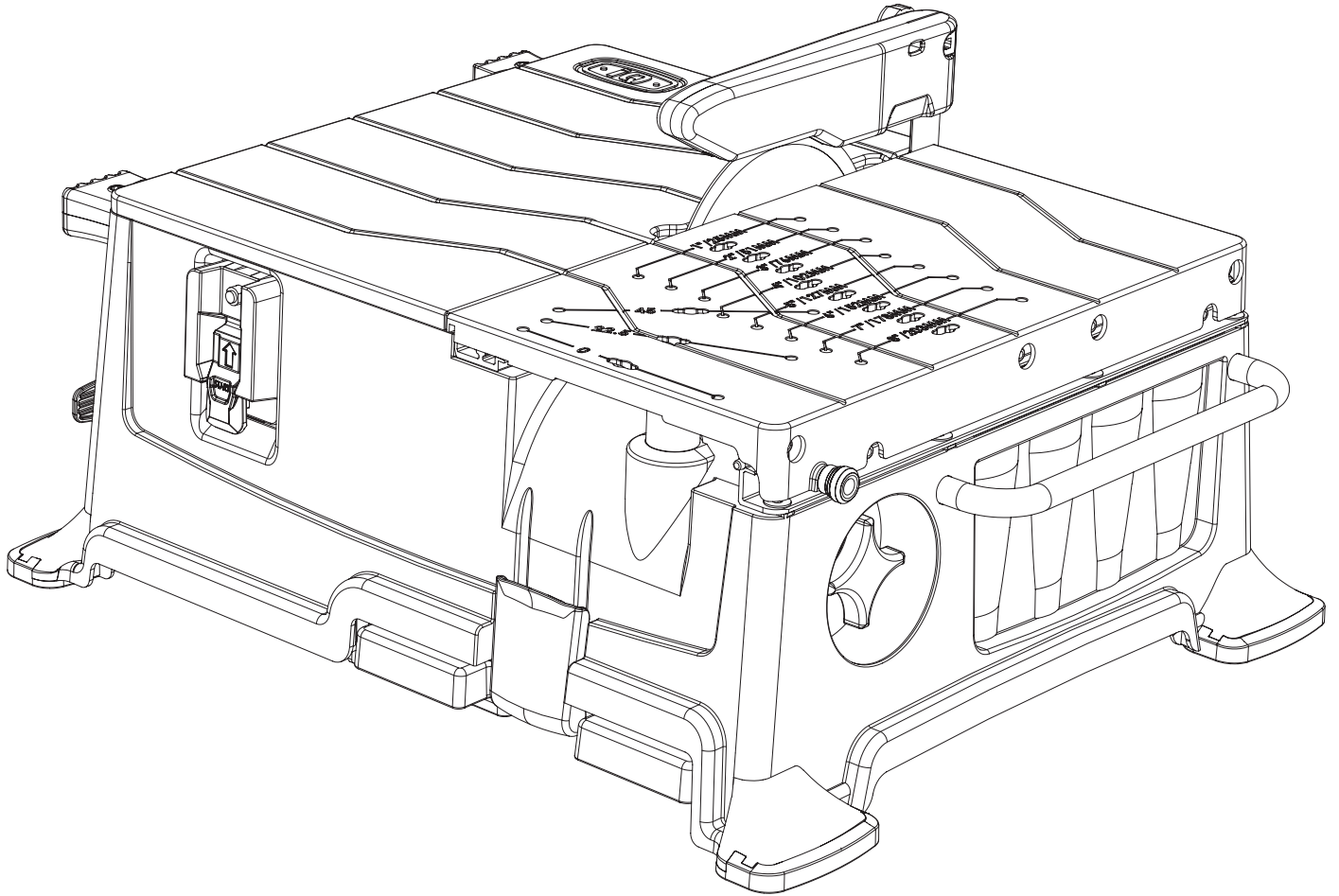

POWER TOOLS™



iQ228CYCLONE™

7" Dry Cut Tabletop Tile Saw



Operator's Manual

Please read the operator's manual carefully and make sure you understand the instructions before using the machine.

Manuel de l'opérateur

Veuillez lire attentivement le manuel d'utilisation et assurez-vous de bien comprendre les instructions avant d'utiliser la machine.

Manual del operador

Lea atentamente el manual del operador y asegúrese de entender las instrucciones antes de utilizar la máquina.

TABLE OF CONTENTS

Topic	Section
Key Symbols & Safety Rules	1
Explanation Of Warning Levels	1.1
Safety Rules	1.3
Introduction	2
Design And Features	2.1
iQ228CYCLONE	2.1
What Is What?	3
Machine's Safety Equipment	4
Safety	5
Personal Protective Equipment	5.1
General Safety Precautions	5.1
Electrical Safety	5.2
Work Area Safety	5.3
Machine Use And Care	5.3
Cutting Wheels	6
Blades For Different Materials	6.1
Assembling	7
Installing The Rolling Table	7.1
Cutting Wheel Installation	7.1
Dust Guard Installation	7.2
Operating	8
Starting And Stopping	8.1
Tru-Cut System	8.1
iQ Micro Fence	8.1
Specialty Cuts	8.2
Transport and Storage	8.3
Dust Collection System	8.3
Vacuum And Filter Maintenance	9
Cleaning The Filter	9.1
Changing The Filter	9.2
Replacing The Carbon Brushes	9.3
Troubleshooting	10
Technical Data	11
Warranty Policy	12

KEY SYMBOLS & SAFETY RULES

Explanation of Warning Levels

The warnings are graded in three levels.

⚠ WARNING

Used if there is a risk of serious injury or death for the operator or damage to the surroundings if the instructions in the manual are not followed.

⚠ CAUTION

Used if there is a risk of injury to the operator or damage to the surroundings if the instructions in the manual are not followed.

⚠ NOTICE

Used if there is a risk of damage to materials or the machine if the instructions in the manual are not followed.

Symbols on the machine



WARNING! The machine can be a dangerous tool if used incorrectly or carelessly, which can cause serious or fatal injury to the operator or others.



Please read the operator's manual carefully and make sure you understand the instructions before using the machine or performing any maintenance.



Always wear hearing protection



Always wear protective goggles or a visor.



High voltage. Risk of an electric shock. Turn off machine and unplug before transportation.



Should not be disposed of with general household waste, but collected separately for reuse or recycling.



Keep your hands and feet away from the cutting wheel.



CSA approved.

Additional Safety Warnings



Do not expose to rain.



Never cut without using the blade guard.



Risk of injury due to accidental starting. Do not use in an area where children may be present.



Unused tile saw may cause personal injury
- Remove this tile saw blade when using other accessories.



Always use manufacturer's approved cutting wheels. Replace damaged cutting wheel before operating.



Use tool only with smooth edge cutting wheels free of openings and grooves.



WARNING : PROP 65

This product can expose you to chemicals, including Cobalt, Lead and Silica Dust which are known to the State of California to cause cancer or birth defects or other reproductive harm. For more information, go to www.p65Warnings.ca.gov.

Ce produit peut vous exposer à des produits chimiques, notamment à la poussière de cobalt, de plomb et de silice, que l'État de la Californie sait qu'ils causent le cancer, des anomalies congénitales ou d'autres effets nocifs sur la reproduction. Pour plus d'informations, allez sur www.p65Warnings.ca.gov.

Este producto puede exponerlo a productos químicos, incluidos cobalto, plomo y polvo de sílice, que el estado de California sabe que causan cáncer, defectos de nacimiento u otros daños irreversibles. Para obtener más información, vaya a www.p65Warnings.ca.gov.

SAFETY RULES

Safety Rules

- 1. KEEP GUARDS IN PLACE** and in working order.
- 2. KEEP WORK AREA CLEAN.** Cluttered areas and benches invite accidents.
- 3. DON'T USE IN DANGEROUS ENVIRONMENT.** Don't use power tools in damp or wet locations, or expose them to rain. Keep work area well lighted.
- 4. KEEP CHILDREN AWAY.** All visitors should be kept safe distance from work area.
- 5. MAKE WORKSHOP KID PROOF** with padlocks, master switches, or by removing starter keys.
- 6. DON'T FORCE TOOL.** It will do the job better and safer at the rate for which it was designed.
- 7. USE RIGHT TOOL.** Don't force tool or attachment to do a job for which it was not designed.
- 8. USE PROPER EXTENSION CORD.** Make sure your extension cord is in good condition. When using an extension cord, be sure to use one heavy enough to carry the current your product will draw. An undersized cord will cause a drop in line voltage resulting in loss of power and overheating. Table A shows the correct size to use depending on cord length and nameplate ampere rating. If in doubt, use the next heavier gage. The smaller the gage number, the heavier the cord.
- 9. WEAR PROPER APPAREL** Do not wear loose clothing, gloves, neckties, rings, bracelets, or other jewelry which may get caught in moving parts. Non-slip footwear is recommended. Wear protective hair covering to contain long hair.
- 10. ALWAYS USE SAFETY GLASSES.** Also use face or dust mask if cutting operation is dusty. Everyday eyeglasses only have impact resistant lenses, they are NOT safety glasses.
- 11. SECURE WORK.** Use clamps or a vise to hold work when practical. It's safer than using your hand and it frees both hands to operate tool.
- 12. DON'T OVERREACH.** Keep proper footing and balance at all times.
- 13. MAINTAIN TOOLS WITH CARE.** Keep tools sharp and clean for best and safest performance. Follow instructions for lubricating and changing accessories.
- 14. DISCONNECT TOOLS** before servicing; when changing accessories, such as blades, bits, cutters, and the like.
- 15. REDUCE THE RISK OF UNINTENTIONAL STARTING.** Make sure switch is in off position before plugging in.
- 16. USE RECOMMENDED ACCESSORIES.** Consult the owner's manual for recommended accessories. The use of improper accessories may cause risk of injury to persons.
- 17. NEVER STAND ON TOOL** Serious injury could occur if the tool is tipped or if the cutting tool is unintentionally contacted.
- 18. CHECK DAMAGED PARTS.** Before further use of the tool, a guard or other part that is damaged should be carefully checked to determine that it will operate properly and perform its intended function - check for alignment of moving parts, binding of moving parts, breakage of parts, mounting, and any other conditions that may affect its operation. A guard or other part that is damaged should be properly repaired or replaced.
- 19. DIRECTION OF FEED.** Feed work into a blade or cutter against the direction of rotation of the blade or cutter only.
- 20. NEVER LEAVE TOOL RUNNING UNATTENDED TURN POWER OFF.** Don't leave tool until it comes to a complete stop.

INTRODUCTION

Dear Customer

We at IQ Power Tools™ want to congratulate you on selecting the iQ228CYCLONE™ 7" Dry Cut Bench Top Tile Saw. We are certain that you will be pleased with your purchase. IQ Power Tools takes pride in manufacturing the most innovative tools and equipment in the industry.

If operated correctly, your iQ228CYCLONE™ should provide you with years of quality service. This operator's manual contains information you need to operate and maintain your iQ228CYCLONE™ safely and correctly. Please take a few minutes to familiarize yourself with your new iQ228CYCLONE™ by reading and reviewing this manual.

If you should have any questions concerning your iQ228CYCLONE™ please feel free to contact us at
Phone: (888) 274-7744
Email: customer.service@iqpowertools.com

It is our wish that you will be satisfied with your product and that it will prove to be a valued tool for a long time. A purchase of one of our products gives you access to professional help with repairs and services. If the retailer who sells your machine is not one of our authorized service center, ask him for the address of your nearest service center.

This operator's manual is a valuable document. Make sure it is always at hand at the work place. By following its content (using, service, maintenance etc.) the life span and the second-hand value of the machine can be extended. If you ever lend or sell this machine, make sure that the borrower/buyer gets the operator's manual, so they will also know how to properly maintain and use it.

Owner Responsibility

It is the owner's/employer's responsibility that the operator has sufficient knowledge about how to use the machine safely. Supervisors and operators must have read and understood the Operator's Manual. They must be aware of:

- The machine's safety instructions.
- The machine's range of applications and limitations.
- How the machine is to be used and maintained.

Local regulations could restrict the use of this machine. Find out what regulations are applicable where you work before you start using the machine.

The Manufacturer's Reservation

Subsequent to publishing this manual IQ Power Tools may issue additional information for safe operation of this product. It is the owner's obligation to keep up with the safest methods of operation.

iQ Power Tools has a policy of continuous product development and therefore reserves the right to modify the design and appearance of products without prior notice.

For customer information and assistance, contact us at our website: www.iQPowerTools.com

Design & Features

Values such as high performance, reliability, innovative technology, and environmental considerations distinguish iQ Power Tools' products. Safe operation of this product requires the operator to read this manual carefully. Ask your dealer or IQ Power Tools should you need more information.

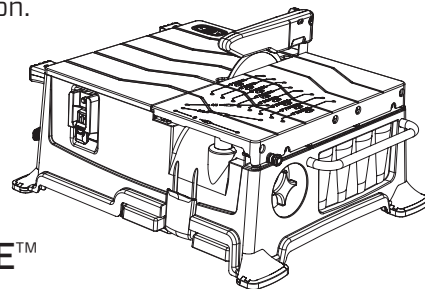

iQ228CYCLONE™

DESIGNED WITH AN INTEGRATED VACUUM SYSTEM, FILTER SYSTEM AND DUST CONTAINMENT

This innovative patent pending design combines the features of a professional tile saw with a powerful cyclonic vacuum system that cuts cleanly and efficiently with no water and no dust.

COMPACT AND MOBILE DESIGN

At under 40lbs, its light weight and compact size makes for easy transport.

LARGE CUT CAPACITY WITH ROLLING TABLE

Enables rip cuts of 18" with rolling table. When rolling table is in locked position, larger size material can be cut.

TRU-CUT™ SYSTEM™

An integrated measurement system that provides consistent and accurate cuts for any job. Includes a Cutting Fence, iQ Micro Fence, and a Rolling Table with preset measurements for straight and angle cuts.

WHAT IS WHAT?

Front

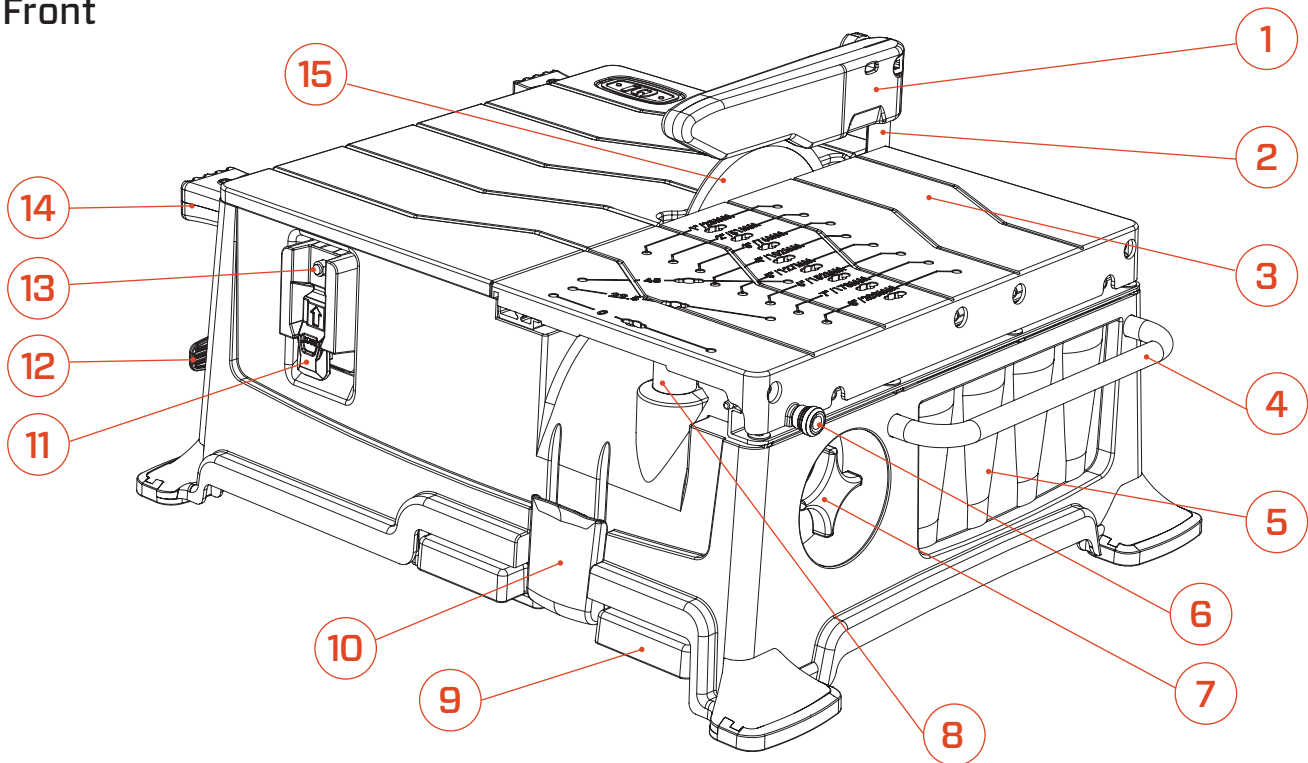

1 - Blade/Dust Guard

2 - Riving Knife

3 - Rolling Table

4 - Lift Handle

5 - Cyclones

6 - Rolling Table Lock Pin

7 - Filter Spin Knob

8 - Toggle Table Stop

9 - Dust Tray

10 - Dust Tray Latch

11 - ON/OFF Switch

12 - Cord Wrap

13 - AMP Overload Switch

14 - Support Foot

15 - Cutting Wheel

WHAT IS WHAT?

Side

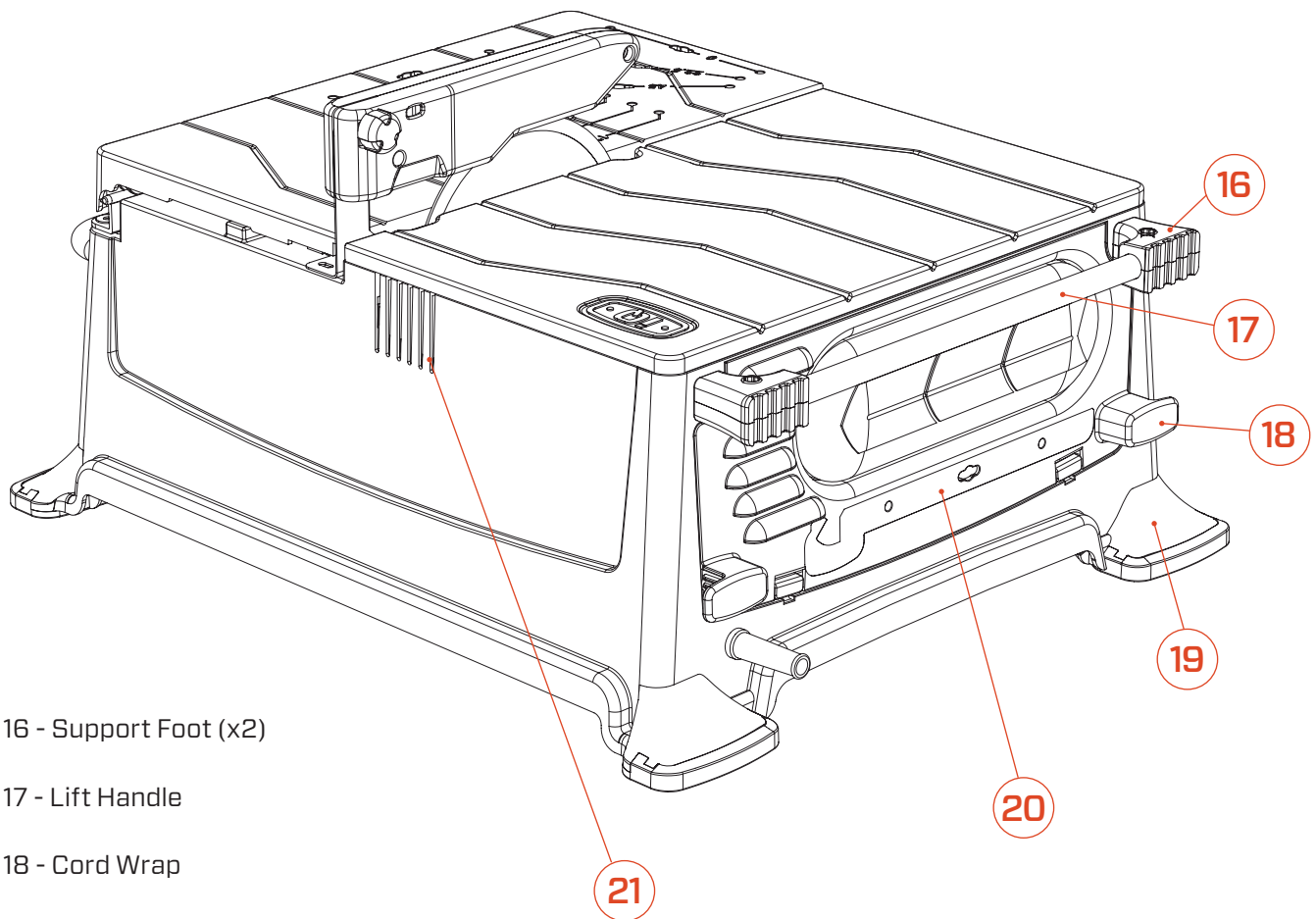

16 - Support Foot (x2)

17 - Lift Handle

18 - Cord Wrap

19 - Bottom Foot (x4)

20 - Fence Storage

21 - Ventilation Holes

Fences

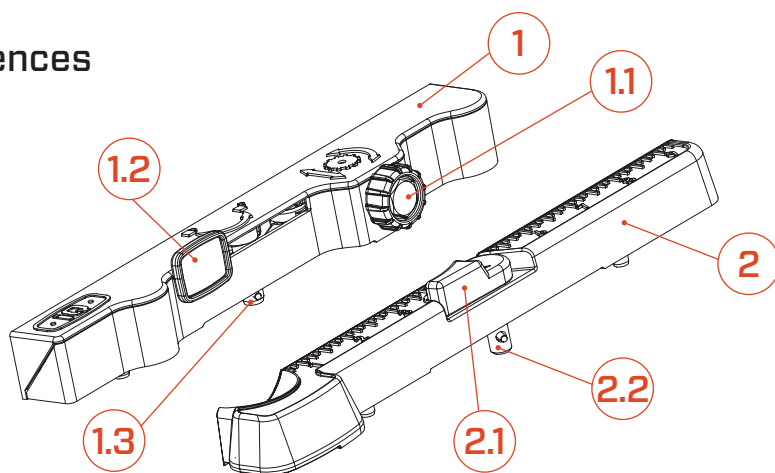

1 - iQ Micro Fence

1.1 - Dial Knob

1.2 - Micro Fence Lever

1.3 - Micro Fence Lock Pin

2 - iQ Standard Fence

2.1 - Standard Fence Lever

2.2 - Standard Fence Lock Pin

MACHINE'S SAFETY EQUIPMENT

General

This section describes the machine's safety equipment, its purpose, and how checks and maintenance should be carried out to ensure that it operates correctly.

⚠ WARNING! NEVER USE A MACHINE THAT HAS FAULTY SAFETY EQUIPMENT

SAW ON/OFF SWITCH

The power switch - / **O** should be used to start and stop the machine.

CHECKING THE SAW ON/OFF SWITCH

To start the saw motor, pull up the On/Off switch.
To stop the saw motor, press down the On/Off switch.
Defective switches should be replaced by an authorized service workshop.



BLADE/DUST GUARD

The blade guard is designed to prevent parts of the blade or cutting fragments from being thrown towards the user. It also aids in capturing dust.

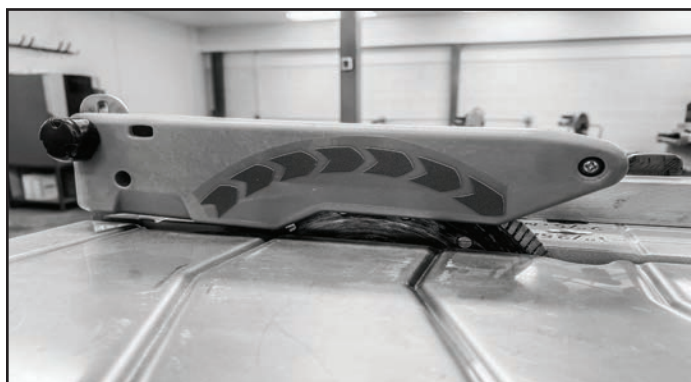

OVERLOAD SWITCH

The overload switch is designed to prevent damage to your saw when the saw motor is overloading.

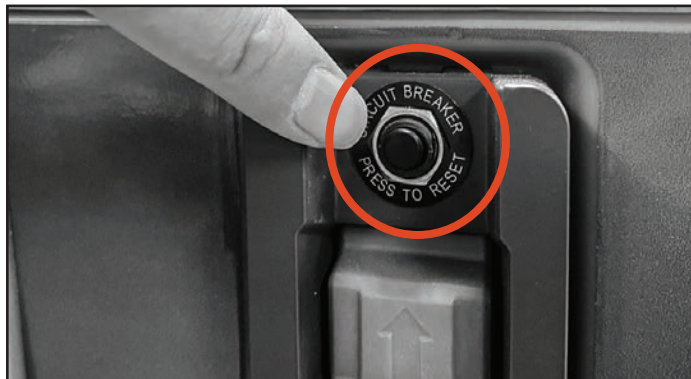

TOGGLE TABLE STOP

The knob is designed to keep the Rolling Table secured to the saw, and prevents it from sliding forward or backward. Please make sure to turn the knob to lock position before transporting the saw.

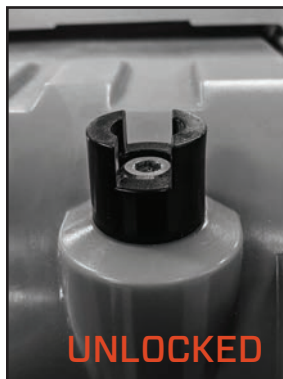

ROLLING TABLE LOCK PIN

The locking pin is used to lock the rolling table in neutral position. Be sure to lock rolling table before transit to avoid injury.

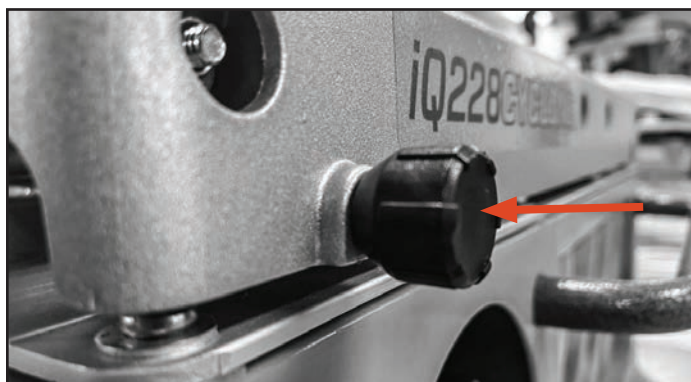

SAFETY

General

Do not use the machine unless you are able to call for help in the event of an accident. Always have a first aid kit nearby.

⚠ WARNING! POWER TOOLS AND CUTTING MACHINES HAVE THE POTENTIAL TO CREATE SPARKS. ALWAYS KEEP FIRE EXTINGUISHERS HANDY.

PERSONAL PROTECTIVE EQUIPMENT

You must use approved personal protective equipment whenever you use the machine. Personal protective equipment cannot eliminate the risk of injury but it will reduce the degree of injury if an accident does happen. Ask your dealer for help in choosing the right equipment.

⚠ WARNING! THE USE OF PRODUCTS SUCH AS CUTTERS, GRINDERS, DRILLS, THAT SAND OR FROM MATERIAL CAN GENERATE DUST AND VAPORS WHICH MAY CONTAIN HAZARDOUS CHEMICALS. CHECK THE NATURE OF THE MATERIAL YOU INTEND TO PROCESS AND USE AN APPROPRIATE BREATHING MASK.

⚠ CAUTION! LONG TERM EXPOSURE TO NOISE CAN RESULT IN PERMANENT HEARING IMPAIRMENT. SO ALWAYS USE APPROVED HEARING PROTECTION.

Listen out for warning signals or shouts when you are wearing hearing protection. Always remove your hearing protection as soon as the motor stops.

⚠ WARNING! THERE IS ALWAYS A RISK OF CRUSH INJURIES WHEN WORKING WITH PRODUCTS CONTAINING MOVING PARTS. WEAR PROTECTIVE GLOVES TO AVOID BODY INJURIES.

Always wear:

- Hearing protection
- Approved eye protection
 - If you use a face shield then you must also wear approved protective goggles. Approved protective goggles must comply with standard ANSI Z87.1 in the USA or EN 166 in EU countries. Visors must comply with standard EN 1731.
- Breathing mask
- Protective gloves.
- Hair covering or devices to contain long hair, i.e.: Hair Ties For Guys

Generally clothes should be close-fitting without restricting your freedom of movement. Be careful as clothing, long hair, and jewelry can get caught in moving parts.

GENERAL SAFETY PRECAUTIONS

This section describes basic safety directions for using the machine. This information is never a substitute for professional skills and experience.

- Please read the operator's manual carefully and make sure you understand the instructions before using the machine. Save all warnings and instructions for future reference.
- Keep in mind that the operator is responsible for accidents or hazards occurring to other people or their property.
- All operators shall be trained in the use of the machine.

The owner is responsible for ensuring that the operators receive training.

- The machine must be kept clean. Signs and stickers must be fully legible.

⚠ WARNING! THE MACHINE CAN BE A DANGEROUS TOOL IF USED INCORRECTLY OR CARELESSLY, WHICH CAN CAUSE SERIOUS OR FATAL INJURY TO THE OPERATOR OR OTHERS.

- Never allow children or other persons not trained in the use of the machine to use or service it.
- Never allow anyone else to use the machine without first ensuring that they have read and understood the contents of the operator's manual.
- Never use the machine if you are fatigued, while under the influence of alcohol or drugs, medication or anything that could affect your vision, alertness, coordination or judgement.

⚠ WARNING! UNAUTHORIZED MODIFICATIONS AND/ OR ACCESSORIES MAY LEAD TO SERIOUS INJURY OR DEATH TO THE USER OR OTHERS.

Do not modify this product or use it if it appears to have been modified by others. Never use a machine that is faulty. Carry out the safety checks, maintenance and service instructions described in this manual. Some maintenance and service measures must be carried out by trained and qualified specialists. See instructions under the heading Maintenance. Always use genuine accessories. Contact your dealer for more information.

SAFETY

ALWAYS THINK ABOUT YOUR WORK ENVIRONMENT AND USE COMMON SENSE.

It is not possible to cover every conceivable situation you can face. Always exercise care and use your common sense. If you get into a situation where you feel unsafe, stop and seek expert advice. Contact your dealer, service agent or an experienced user. Do not attempt any task or operation that makes you feel unsure whether or not it is safe.

ELECTRICAL SAFETY

WARNING! There is always a risk of shocks from electrically powered machines. Avoid unfavourable weather conditions and body contact with lightning conductors and metal objects. Always follow the instructions in the Operator's manual to avoid damage.

▲ WARNING! WHEN CLEANING THE MACHINE MAKE SURE TO AVOID WATER ENTERING THE ELECTRICAL SYSTEM AND THE MOTOR UNIT. WATER CAN CAUSE DAMAGE TO THE MACHINE OR SHORT CIRCUIT.

- Never connect the machine to a outlet if plug or cord is damaged.
- Check that the mains voltage corresponds with that stated on the rating plate on the machine.
- Inspection and/or maintenance should be carried out with the motor switched off and the plug disconnected.
- Always shut down the machine before disconnecting the power plug.
- Never drag the machine by means of the cord and never pull out the plug by pulling the cord. Hold the plug to disconnect the power cord.
- Never use the machine if any cable or plug is damaged, but hand it in to an authorized service workshop for repair.
- Never use the machine if any cable or plug is damaged, but hand it in to an authorized service workshop for repair.
- Prevent unintentional starting of the motor. Ensure the power switch is in the **OFF**-position before connecting the machine to a power source.

Do not modify the plug. If it will not fit the outlet have a proper outlet installed by a qualified electrician. Make sure local regulations and ordinances are followed.

▲ WARNING! IMPROPER CONNECTION CAN RESULT IN THE RISK OF ELECTRIC SHOCK. CONTACT A QUALIFIED ELECTRICIAN IF IN DOUBT AS TO WHETHER THE APPLIANCE IS PROPERLY GROUNDED.

EXTENSION CORDS AND CABLES

The marking on the extension cable must be the same or higher than the value stated on the machine's rating plate.

- When operating a power tool outdoors, use an extension cord suitable for outdoor use. Use of a cord suitable for outdoor use reduces the risk of electric shock.
- Keep the connection to the extension cord dry and off the ground.
- Keep cable away from heat, oil, sharp edges or moving parts. Damaged or entangled cable increase the risk of electric shock.
- Check that the cord and extension cord are intact and in good condition. Never use the machine if any cable or plug is damaged. Take it into an authorized service workshop for repair.
- To avoid overheating do not use the extension cord while it is rolled up.
- When using an extension cable, use only certified extension cables with sufficient reach.

▲ NOTICE! GOOD MOTOR PERFORMANCE DEPENDS ON PROPER VOLTAGE. EXTENSION CABLES THAT ARE TOO LONG AND/OR WHICH HAVE A GAGE THAT IS TOO SMALL, REDUCE POWER TO THE MOTOR UNDER LOAD, RESULTING IN REDUCED OUTPUT OR MALFUNCTIONS.

SAFETY

WORK AREA SAFETY

- Keep work area clean and well lit. Cluttered or dark areas invite accidents.
- People and animals can distract you causing you to lose control of the machine. For this reason, always remain concentrated and focused on the task.
- Do not use the machine in bad weather, such as dense fog, heavy rain, strong wind, intense cold, etc.
- Never start to work with the machine before the working area is clear and you have a stable work surface.
- Secure Work - use clamps or a vise to hold work when practical. It is safer than using your hand and it frees both hands to operate tool.

PERSONAL SAFETY

Never use the machine if you are fatigued, while under the influence of alcohol or drugs, medication or anything that could affect your vision, alertness, coordination or judgement.

- Check that no tools or other objects have been left lying on the machine.
- Never allow anyone else to use the machine without proper training.
- Always shut off the machine during longer work breaks.
- Never work alone, always ensure there is another person close at hand.
- Learn how to use the machine and its controls safely and learn to how to stop quickly. Also learn to recognize the safety decals.
- Keep handles dry, clean and free from oil and grease.
- Do not overreach. Keep proper footing and balance at all times.
- Never stand on the machine.

MACHINE USE AND CARE

- This machine is designed and intended for cutting tile and stone. All other use is improper.
- Experience is very important when running the machine. A skilled worker is highly recommended.
- The machine is intended for use in industrial applications by experienced operators.
- Check that the machine is assembled correctly and do not show any signs of damage.
- Always perform daily maintenance before starting the machine. See instructions in the section "Maintenance".
- Do not overload the machine. Overloading can damage the machine.
- The blade shall be intended for the material to be cut.
- If you are uncertain of what blade to use contact your local service dealer.
- Keep tools sharp and clean in order to enable safer work.
- Keep all parts in good working order and ensure that all fixtures are properly tightened. Replace all worn or damaged decals.
- Never leave the machine unsupervised with the motor running.
- Feed the work piece against the rotation of the blade only!
- Observe care when lifting. You are handling heavy parts, which imply the risk of pinch injuries or other injuries.

CUTTING WHEELS

General

⚠ WARNING! CUTTING WHEELS CAN BREAK AND CAUSE SERIOUS INJURIES TO THE USER. DIAMOND CUTTING WHEELS CAN BECOME VERY HOT WHEN NOT USED PROPERLY. AN OVERHEATED CUTTING WHEEL MAY CAUSE DEFORMATION OF THE WHEEL, RESULTING IN DAMAGE AND INJURIES.

The iQ228CYCLONE dry cutting tile saw utilizes a specially designed diamond cutting wheel with a Q-Drive Arbor hole. The 7" Q-Drive dry cutting wheel uses a proprietary composition of diamond concentration, metal type, and flange thickness to make a cutting wheel that cuts cool while reducing vibration and movement. The specially designed blade works in conjunction with the vacuum flow to keep the blade and the material cool while cutting.

The iQ228CYCLONE 7" Tabletop Dry Cutting wheels with Q-Drive Arbor hole can be purchased from your local iQ Power Tools dealer or directly from iQ Power Tools by calling 888-274-7744 or through our website at www.iqpowertools.com

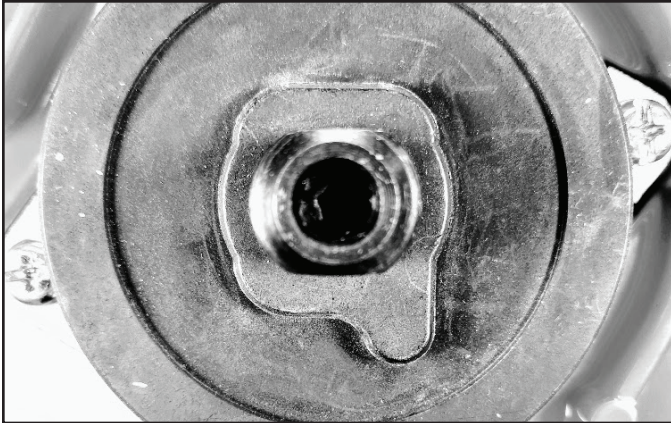

The Q-Drive Arbor hole with the included bushing also fits a standard 5/8" round blade shaft for versatility.

The Q-Drive Arbor hole shape without bushing also fits a standard 1" round blade shaft for versatility.



WITH BUSHING

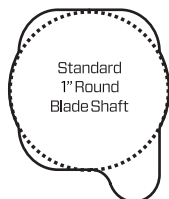

WITHOUT BUSHING

Blades for Different Materials

⚠ WARNING! NEVER USE A CUTTING WHEEL FOR ANY OTHER MATERIALS THAN THAT IT WAS INTENDED FOR. CUTTING PLASTICS WITH A DIAMOND CUTTING WHEEL CAN CAUSE KICKBACK WHEN THE MATERIAL MELTS DUE TO THE HEAT PRODUCED WHEN CUTTING AND STICKING TO THE WHEEL. NEVER CUT PLASTIC MATERIALS WITH A DIAMOND CUTTING WHEEL!

The iQ228CYCLONE dry cut tabletop tile saw is supplied with specially designed 7" Dry Cutting Combination Blade with Q-Drive Arbor hole that is engineered to cut a variety of material such as: porcelain, marble, granite, ceramic, and stone.

A 7" Dry Cutting Hard Material Blade is also available for the iQ228CYCLONE with Q-Drive Arbor hole.

Cutting Wheel selection should be made according to the material being cut ask your local dealer for help in choosing the right product.

VIBRATIONS

- The blade can become out of round and vibrate if a too high feed pressure is used.
- A lower feed pressure can stop the vibration. Otherwise replace the blade.

SHARPENING DIAMOND CUTTING WHEELS

- Always use a sharp diamond cutting wheel
- Diamond can become dull when the wrong feeding pressure is used or when cutting certain materials such as very hard material. Working with a dull diamond cutting wheel causes overheating, which can result in the diamond segments coming loose.
- Sharpen the cutting wheel by using a dressing stone or by cutting in a soft material such as sandstone or soft brick.

TRANSPORT AND STORAGE

- Remove the cutting wheel before transportation or storage of the machine.
- Store the cutting wheel in a dry place.
- Inspect new cutting wheels for transport or storage damage.

ASSEMBLING

UN-BOXING

Open the top of the box. Remove top layer of foam. Lift the iQ228CYCLONE saw out of the box and place on a flat horizontal and stable surface (preferably a workbench) to prevent the equipment from tipping or sliding during assembly.

INSTALLING CUTTING WHEEL

Remove out the 7" Dry Cutting Combo Blade and Blade/Dust Guard from the box

Lift the dust tray latch and pull the dust tray out.



Lay the iQ228CYCLONE on the side with Support Foot.



Reach inside to remove blade shaft nut and outside flange washer with the Metal Blade Wrench, and fit the cutting wheel onto Q-Drive Arbor.



Note the Q-Drive shaped blade shaft. Make sure the blade sits on the Q drive properly. The iQ228CYCLONE must be used with the specially designed 7" dry cutting blade with Q-Drive Arbor hole.



Keep pressing down the gear lock tab and use the Metal Blade Wrench to tighten the shaft nut.

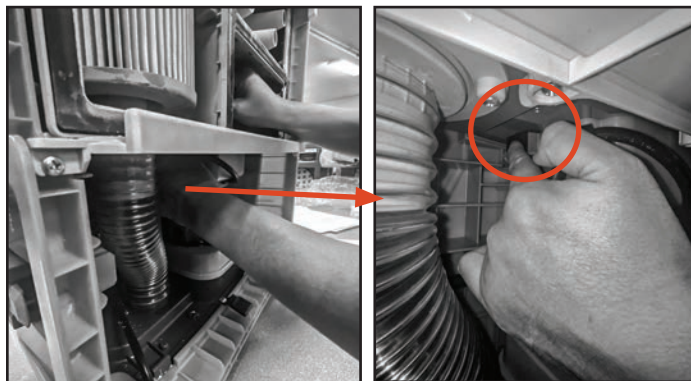

Slide the dust tray back into the saw, make sure the tray is pushed all the way in. Engage the latch to lock the tray.



ASSEMBLING

INSTALLING BLADE/DUST GUARD

Remove the blade/dust guard and Riving Knife from the box.

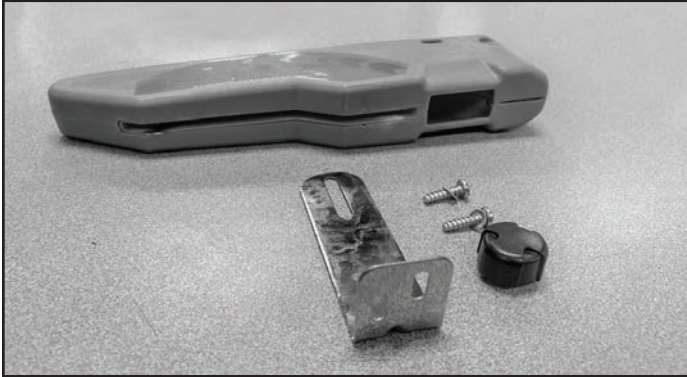

Place the Riving Knife on the main housing and install the two screw/washer at the foot of the Riving Knife.



Place a speed square/straight edge next to the blade to make sure both blade and Riving Knife are aligned.



Remove the knob and screw from the Blade/Dust Guard. Slide the blade guard over the Riving Knife, replace screw and knob and tighten.

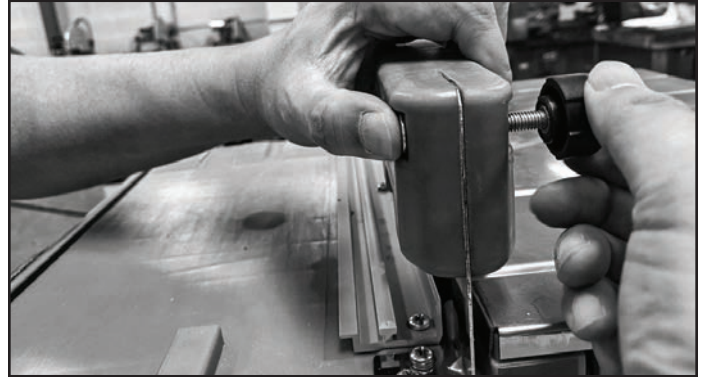

NOTE: Adjust the Blade/Dust Guard position on the Riving Knife based on the different height of the material.

INSTALLING ROLLING TABLE

Rotate toggle table stop to unlock position.

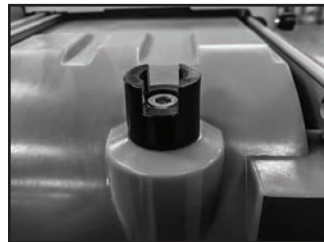

Align the wheels on the track and slide the rolling table onto the track of the saw. Turn the toggle table stop to lock position.



Pull the lock pin and pull the rolling table back until the lock pin engages with the lock hole.



OPERATING

Before starting

⚠ WARNING! PLEASE READ THE OPERATOR'S MANUAL CAREFULLY AND MAKE SURE YOU UNDERSTAND THE INSTRUCTIONS BEFORE USING THE MACHINE

Wear personal protective equipment. See instructions under the heading "Personal protective equipment". Make sure no unauthorised persons are in the working area, otherwise there is a risk of serious personal injury. Prevent unintentional starting of the motor. Ensure the power switch is in the OFF- position before connecting the machine to a power source.

Check that the machine is assembled correctly and do not show any signs of damage. See instructions in the section "Assembling and adjustments".

- Perform daily maintenance. See instructions in the section "Maintenance".

STARTING MACHINE

To start the saw motor, pull the On/Off switch up to on position. Defective switches should be replaced by an authorized service workshop.

STOPPING MACHINE

To stop the saw motor, press down the On/Off switch to off position.

⚠ WARNING! MAKE SURE CUTTING BLADE COMES TO A COMPLETE STOP BEFORE PERFORMING ANY MAINTENANCE OR TRANSPORTING.

Tru-Cut™ System

The iQ Tru-Cut™ System is industry's first fully integrated measurement system that provides consistent and accurate cuts. It utilizes two fences and a pre-measured rolling table. The measurements on the rolling table provide easy guidance for various cuts, such as 45 and 22 angle cuts.

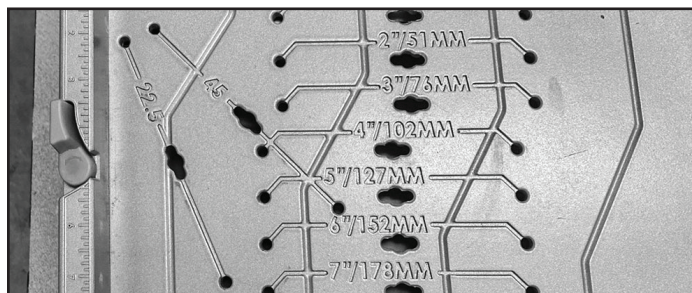

The Tru-Cut™ System's two fences, a standard fence and the iQ Micro Fence, come attached to your iQ228CYCLONE saw.

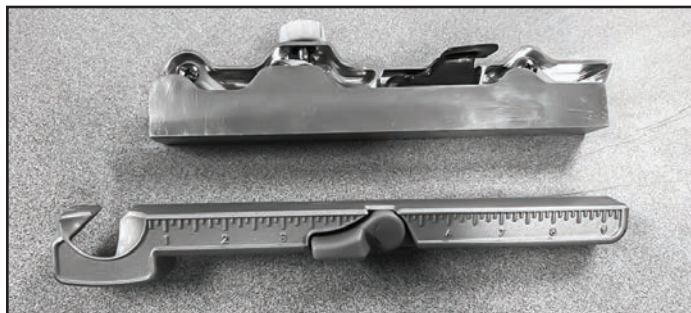

IQ MICRO FENCE

The iQ Micro Fence is an adjustable fence tool that provides accurate measurements for your cuts. Install the Micro Fence onto the Rolling Table according to the desired angle or position, then dial the knob to move the cutting material for desired measurement.

Use the three pins in the bottom of the iQ Micro Fence to align the fence with the three holes for the selected spot in the rolling table.

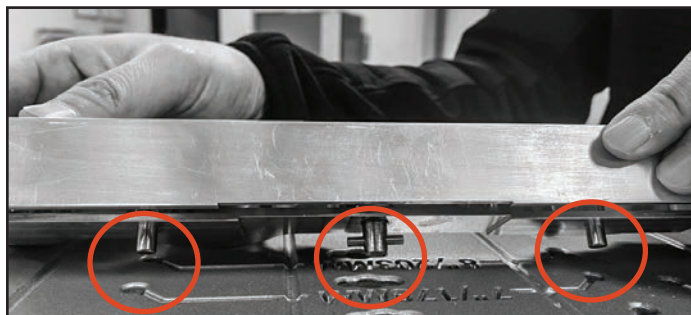

Then use the black latch on the side of the iQ Micro Fence to lock it into place.

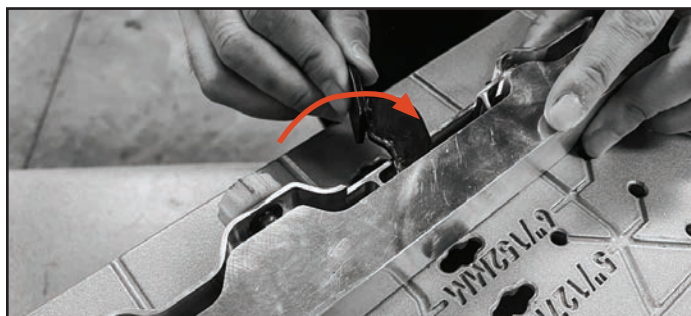

OPERATING

Spin the knob to the exact measurement you need and then make your cut.

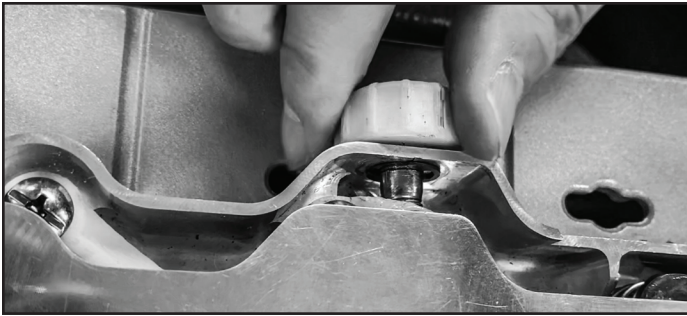

USING FENCE AS PUSH FENCE

Install the fence to the rolling table. Pull the Lock pin on the rolling table and move the rolling table to a desired location for the cut material, and you can push the fence to start.

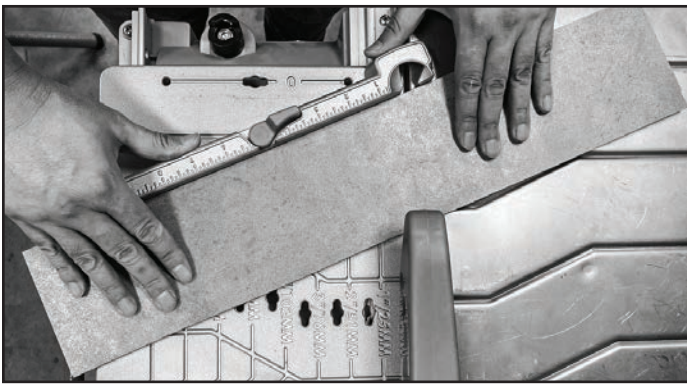

Press the material firmly against the rolling table fence and feed the material into the cutting wheel.

CUTTING WITHOUT FENCE

When the material is larger than 18" (457mm) in diagonal, you have the option to remove the fence to cut. We recommend to push the rolling table back into locking position, and push the pin to lock the table before start cutting.

Speciality Cuts

MAKING A CROSS CUT

Cross cuts are straight 90° cuts. The material is fed into the saw at a 90° angle to the blade.

- Use a marker or grease pencil to mark the area to be cut on material.
- Place the material on the table, firmly against

the rolling table fence.

- Make sure the material is clear of the blade before turning on the saw.
- Turn power switch to ON position.
- Hold the material firmly against the rolling table fence and feed the material into the blade.
- When the cut is made, turn the saw OFF. Wait for the blade to come to a complete stop before removing any part of the material.

MAKING A DIAGONAL OR MITER CUT

45° diagonal cuts are referred to as "long point-to-long point cuts". Miter cuts are used for cutting outside and inside corners on material. Miter cuts tend to "creep" during cutting. This can be controlled by holding the material securely against the fence.

- Using a marker or grease pencil to mark the area to be cut on the material.
- Install the fence to desired measurement location on the rolling table, and you may use the micro adjuster to dial into desired measurement.
- Place the material on the table and firmly against the fence.
- Make sure the material is clear of the blade before turning on the saw.
- Turn power switch to ON position.
- Hold the material firmly against the rolling table fence and feed the material into the blade.
- When the cut is made, turn the saw OFF. Wait for the blade to come to a complete stop before removing any part of the material.

MAKING L-CUT

L-cuts are cuts that remove a piece of tile to fit in a corner. Note: Only over cut on the bottom or underneath side of the material being cut.

- Using a marker or grease pencil to mark the area to be cut on the material.
- Install the fence to desired measurement location on the rolling table, and you may use the micro adjuster to dial into desired measurement.
- Place the material on the table and firmly against the fence.
- Make sure the material is clear of the blade before turning on the saw.
- Turn power switch to ON position.
- Hold the material firmly against the rolling table fence and feed the material into the blade.

OPERATING

- Make the cut far enough into the material without over-cutting.
- When the cut is made, turn the saw OFF. Wait for the blade to come to a complete stop before removing any part of the material.
- Turn the material over and make the second cut along one of the marks, or use your micro adjuster to dial into desired cut location.
- When the cut is made, turn the saw OFF. Wait for the blade to come to a complete stop before removing any part of the material.

Maintenance

▲ WARNING! PLEASE READ THE OPERATOR'S MANUAL CAREFULLY AND MAKE SURE YOU UNDERSTAND THE INSTRUCTIONS BEFORE USING THE MACHINE

GENERAL

To prevent accidental starting, the steps described in this chapter must be performed with the motor off and the power cable removed from the socket, if not otherwise stated.

Wear personal protective equipment. See instructions under the heading "Safety". The life span of the machine can be reduced and the risk of accidents can increase if machine maintenance is not carried out correctly and if service and/or repairs are not carried out professionally. If you need further information please contact your nearest servicing dealer.

DAILY MAINTENANCE

- Check that the machine's safety equipment is undamaged. See instructions in the section "Machine's safety equipment".
- Clean the outside of the machine. Do not use a high pressure washer to clean the saw.
- Open the blade guard. Clean both the inside and outside, and close the blade guard.
- Check blade/dust guard. Clean both the inside outside, and close the blade/dust guard.
- Check rolling table. Slide the table forward to clean the tracks, and pull the table back to lock position and lock the table with lock pin.
- Check cutting wheel to ensure the cutting wheel is not damaged or loose. Perform cutting wheel dressing and/or tighten the cutting wheel to the shaft as needed.

Transport and Storage

Turn off the saw motor and disconnect the power cable prior to lifting or moving the machine.

- Ensure that the rolling table is locked in its locked position.
- Lift the machine on the shorter handle, and lay the machine on its support feet when need to keep the machine in up-right position.
- Remove cutting wheel

Dust Collection System

FILTER SYSTEM

Filter system of the iQ228CYCLONE™ is designed to function automatically with the tile saw. The system is designed to operate for the full work day or 200 lineal feet of cutting before cleaning filter or emptying dust tray.

CLEANING THE FILTER AND EMPTYING DUST TRAY

Spin filter three times after 200 L.F. of cutting or at the end of each day. Spin filter before emptying dust collection tray.

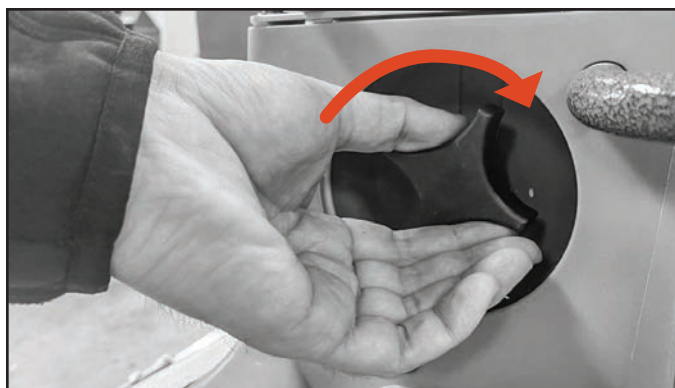

Pull dust tray latch to unlock the tray.



VACUUM AND FILTER MAINTENANCE

Slide dust tray out. Empty dust into bag or sealed container and dispose properly.



CHANGING THE FILTER AND FILTER CLEANING TAB

Filter and cleaning tab should be changed once a year.

Remove the dust tray and place the saw on its support feet.

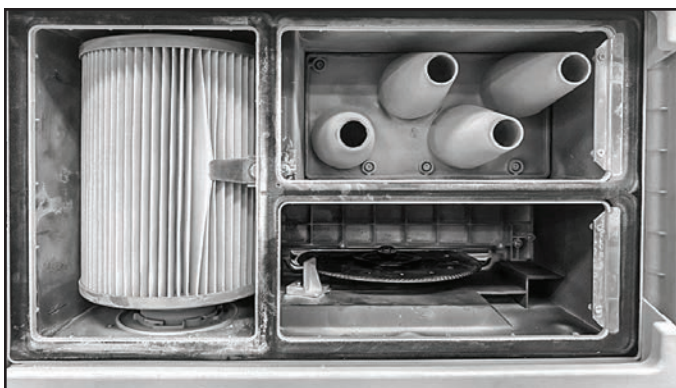

Turn the filter spindle and hose counter-clockwise until it stops, then pull the spindle away from the filter to remove the spindle.

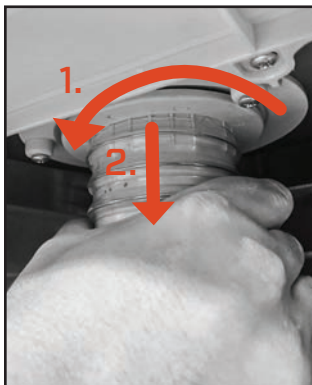

Hold the filter and unscrew the filter spin knob. Slide the filter out by turning the filter left and right.

Note: This may take force.



To remove the old filter cleaning tab, unscrew the screw with Philips screw driver, and replace with a new one that is included in the filter replacement package.

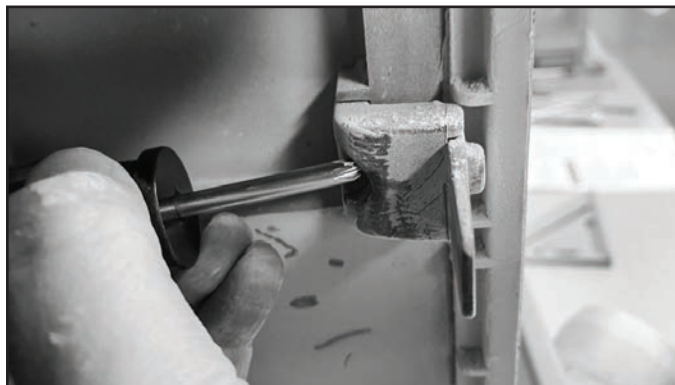

INSTALLING NEW FILTER

Take the new filter from the filter replacement package. Rotate the filter slightly so it can slide into the filter housing. Then align the screw on the top of the filter with the opening on the housing.



VACUUM AND FILTER MAINTENANCE

Place the filter spin knob back over the screw, then screw it back to the original lock position.

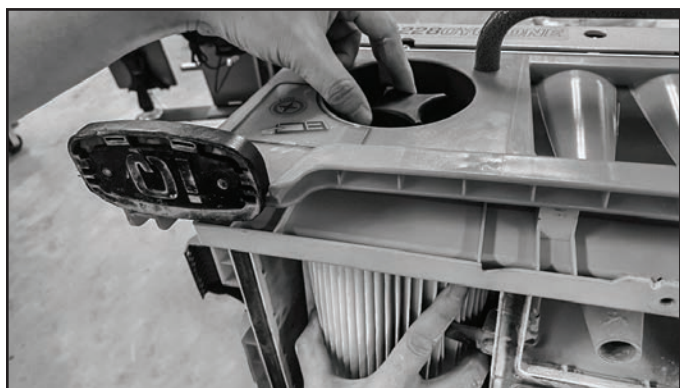

INSTALL FILTER SPINDLE AND HOSE.

Move and position the spindle back into the middle opening of the filter, then turn the spindle clockwise until it stops to lock the spindle.



To remove carbon brush retainer cap, un-tighten carbon brush retainer cap with a flat head screwdriver.

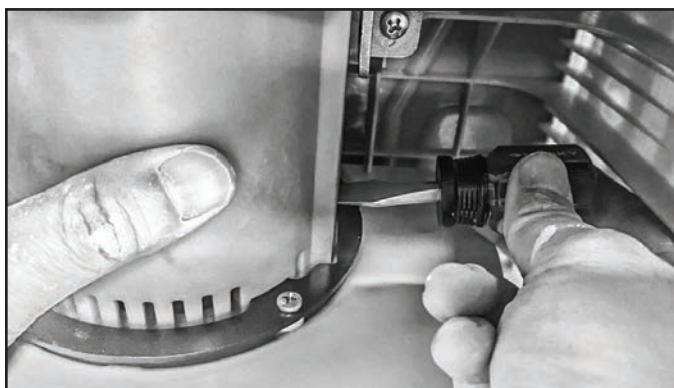

Remove carbon brush. Inspect carbon brush and replaced it necessary



Install carbon brush making sure to align tabs into slots. Tighten carbon brush retainer cap to secure. Repeat on both sides.

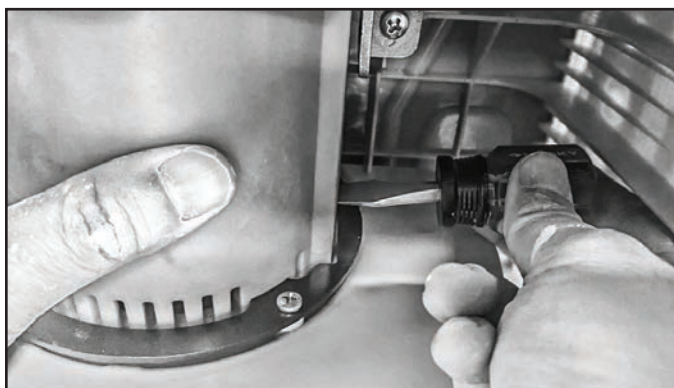

⚠ WARNING! MAKE SURE CUTTING WHEEL COMES TO A COMPLETE STOP BEFORE PERFORMING ANY MAINTENANCE OR TRANSPORTING.

CARBON BRUSHES.

The carbon brushes must be removed and checked regularly. Monthly if the machine is used daily. These instructions apply to the saw motor and the vacuum motor. The two carbon brushes are located on the two opposite sides of the motor.

TROUBLESHOOTING GUIDE

BE SURE TO FOLLOW SAFETY RULES AND INSTRUCTIONS
MANY COMMON PROBLEMS CAN BE SOLVED EASILY BY UTILIZING THE CHART BELOW.
FOR MORE SERIOUS OR PERSISTENT PROBLEMS, CONTACT IQ POWER TOOLS AT 1-(888)274-7744.

TROUBLE! SAW WILL NOT START

WHAT'S WRONG?	WHAT TO DO
1. Saw not plugged in	1. Plug in saw
2. GFCI tripped	2. Push switch to off and push reset button on GFCI
3. Saw will not run (plugged in; switch on)	3. Push the On/Off switch to off position and push the overload switch to reset the machine, then pull the On/Off switch to on position.
4. Saw will not run (plugged in; switch on)	4. Push switch to off and push the reset button on the GFCI
5. Fuse blown or circuit breaker tripped	5. Push switch to off and replace fuse or reset circuit breaker.
6. Cord damaged	6. Have cord replaced by authorized service center.
7. Brushes worn out	7. Have brushes replaced by authorized service center.

TROUBLE! SAW MAKES UNSATISFACTORY CUTS

WHAT'S WRONG?	WHAT TO DO
1. Dull cutting blade	1. Use dressing stone, and/or replace cutting wheel
2. Blade not cutting	2. Use dressing stone, and/or replace cutting wheel
3. Build up on cutting wheel	3. Use dressing stone to remove build up

TROUBLE! CUTTING WHEEL DOES NOT COME UP TO SPEED

WHAT'S WRONG?	WHAT TO DO
1. Extension cord too small of a wire gauge or too long	1. Replace with adequate size cord
2. Arbor loose	2. Tighten arbor
3. Low house voltage	3. Contact your electric company

TROUBLE! MACHINE VIBRATES EXCESSIVELY

WHAT'S WRONG?	WHAT TO DO
2. Stand or bench on uneven floor	2. Reposition on flat level surface
3. Damaged saw cutting wheel	3. Replace cutting wheel.

TROUBLE! DOES NOT MAKE ACCURATE CUTS

WHAT'S WRONG?	WHAT TO DO
1. Cutting guide not secure to fence	1. Check and adjust
2. Cutting wheel is not square to fence	2. Check and adjust
3. Cutting wheel is not perpendicular to table surface	3. Check and adjust fence
4. Work piece moving	4. Use edge guide.

TROUBLE! LOSS OF VACUUM SUCTION

WHAT'S WRONG?	WHAT TO DO
1. Filter plugged	1. Spin filter cleaning knob
2. Dust tray in unlocked position	2. Lock dust tray in up position
3. Dust tray over filled with dust	3. Empty dust tray and remove dust build up around filter and cyclones.

TECHNICAL DATA

iQ228CYCLONE™, 120V

POWER, KW	1800 WATT
VOLTAGE, V/AMP	120/15
PHASES	1
FREQUENCY, HZ	60
BLADE SPEED, RPM	6000

CUTTING EQUIPMENT

CUTTING WHEEL SIZE - MAX, INCH/MM	7/180
SAW DEPTH - MAX, INCH/MM	1"
CUTTING LENGTH - MAX, INCH/MM	18"
ARBOR CONFIGURATION	Q-DRIVE

DIMENSIONS

UNIT WEIGHT (LB/KG)	36/16.3
SHIPPING WEIGHT (LB/KG)	40/18.2
SIZE (LXWXH), INCH/MM	25.2 X 21.3 X 13.4 / 640 X 540 X 340 MM
SHIPPING DIMENSIONS (LX W X H), INCH/MM	27.2 X 23.2 X 13.8 INCH / 690 X 590 X 350 MM

TABLE A

TOTAL CORD LENGHT	25FT	50FT	100FT	150FT
VOLTS	120V	120V	120V	120V
MIN GAUGE CORD (AWG)	12	10	NOT RECOMMENDED	NOT RECOMMENDED

WARRANTY

New iQ228CYCLONE™ 7" Dry Cut Tabletop Tile Saw, sold by iQ Power Tools or an iQ authorized dealer is warranted to be free from manufacturing defects in normal service for a one year period from date of purchase by the original consumer purchaser. Warranty period for rental items is 90 days.

All iQ products must be registered either through our website or by mailing in the Warranty Card in order for the warranty to be active and valid. This Warranty shall not apply to any parts that have been subjected to misuse or improper service, damaged in transit or handling, altered or repaired by unauthorized representatives, or used with a blade that is not recommended by iQ Power Tools.

Any claim arising under this Warranty must be submitted by the original purchaser within the Warranty period specified above and must include proof of purchase. Within Warranty period, options are either to replace or repair any parts or components that are found to be defective by iQ Power Tools at no charge to the original purchaser. iQ Power Tools shall not be responsible or obligated to pay for freight or other transportation-related costs or expenses in connection with any defective products, replacements, or components that are returned to iQ Power Tools facility or any authorized repair station.

Parts and labor needed to maintain products, and the replacement of components due to normal wear and tear, are the purchaser's responsibility and are not covered by this Warranty. All products or components replaced under Warranty become the property of the manufacturer. All replacement parts will be considered to be part of the original product and any Warranty on such parts will expire concurrently with this original Warranty.

iQ Power Tools will pay for parts and labor in connection with Warranty repairs conducted by iQ Power Tools or its authorized repair center. Replacement parts installed by anyone else will be provided without a charge but this Warranty will not apply to labor charges in connection therewith.

IN NO EVENT SHALL ANY LIABILITY UNDER THIS WARRANTY EXCEED THE REPLACEMENT COST OF ANY DEFECTIVE PRODUCT OR COMPONENT THEREOF. iQ POWER TOOLS SHALL NOT BE LIABLE FOR ANY INCIDENTAL OR CONSEQUENTIAL DAMAGES OR FOR ANY OTHER DAMAGE OR LOSS NOT EXPRESSLY ASSUMED AS SET FORTH HEREIN.

The Warranty on the terms above is the only Warranty. This limited Warranty is expressly in lieu of all other Warranties, whether expressed or implied.



POWER TOOLS

888-274-7744 | WWW.IQPOWERTOOLS.COM